

# Combustion Parts for Power Generation

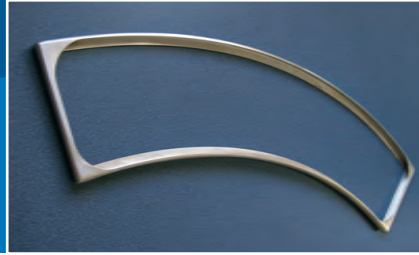

*Seal fabricated and machined from 300 series stainless steel.*

Consolidated Fabricators™ (ConFab) supplies a wide range of high temperature, corrosion-resistant combustion system parts for power generation, including seals, retainers, brackets, wirelocks and others.

We meet or exceed stringent customer expectations for tight tolerances on precision fabricated components requiring forming, welding, CNC machining and CMM inspection. Parts are fabricated from an extensive offering of alloys, including:

- all grades of stainless steel
- Inconel® alloys
- Hastalloy® alloys
- Aluminum alloys
- Copper alloys

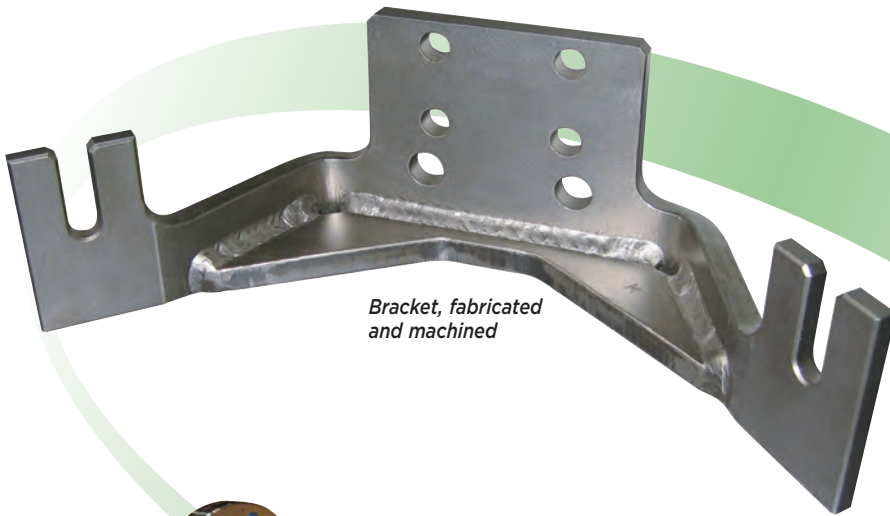

*Bracket, fabricated and machined*

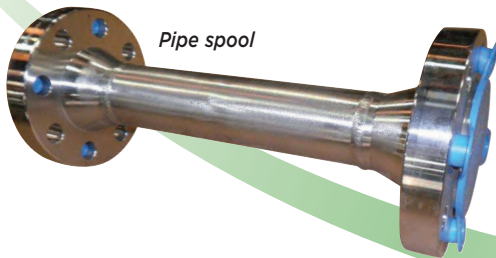

*Pipe spool*

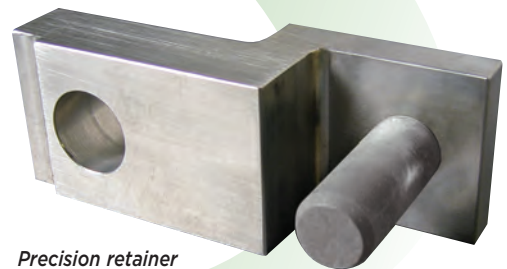

*Precision retainer*

## Research, Design and Prototyping Services

ConFab can help you with better parts! Bring your challenging situations to our engineers and we can research, diagnose and design an improved version of an existing combustion part. Capabilities to design and produce production tooling, along with soft tooling designs for prototyping and short runs can be accommodated within our Engineering and Manufacturing programs.

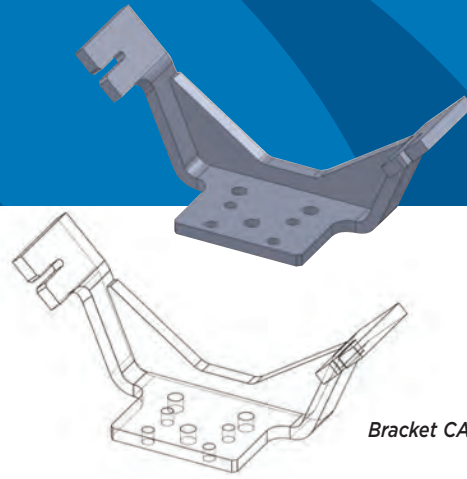

*Bracket CAD drawing*

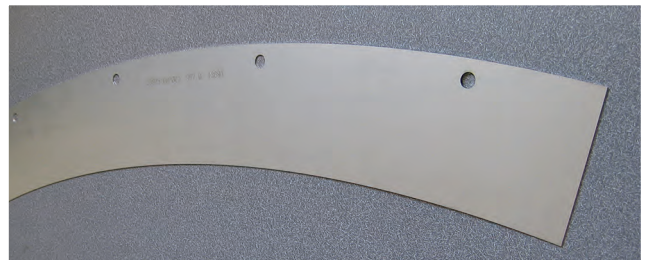

*Locking device*



*Lock plate*

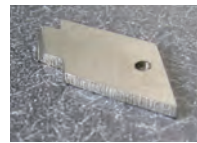

*Seals*



*Collar*



*Tube*

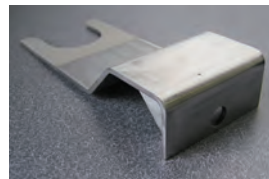

*Retainers*



AN INNOVA GLOBAL COMPANY

17 St. Mark Street  
Fairfax Industrial Park  
Auburn, MA 01501 USA

Tel: 508-797-8000  
Fax: 508-832-7369  
Email: [sales@consolidatedfabricators.com](mailto:sales@consolidatedfabricators.com)

[www.consolidatedfabricators.com](http://www.consolidatedfabricators.com)